

# Doormerica

## ECL - Residential Cylindrical Latchset-Grade 3

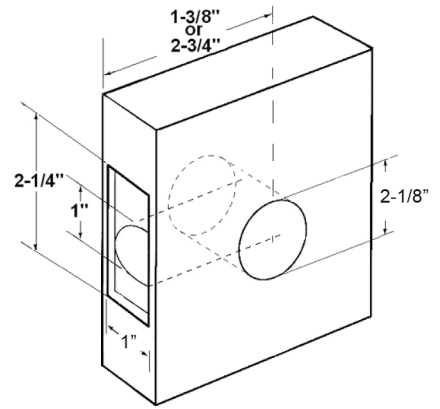
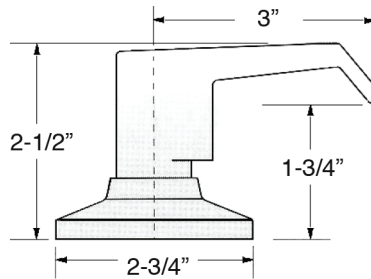
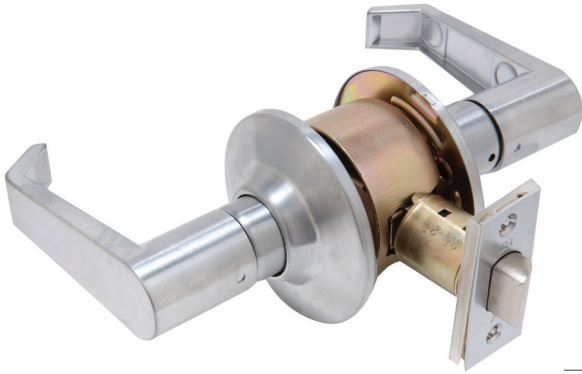

### Features:

- Non-handed and reversible
- PECL-SIADJ -Adjustable backset, 2-3/8" or 2-3/4"
- 1" x 2-1/4" faceplate spring latch
- PLKT-2-3/4" x 1-1/4" -"1" strike
- LEV lever trim only
- Barrier free
- Door thickness 1-3/8" -1-3/4"

### Options:

- PLKFL -2-1/4" x 1-1/4" full lip strike (SOLD SEPERATELY)
- PLKASA -4-7/8" x 1-1/4" ASA strike (SOLD SEPERATELY)
- PECL26DRD- round corner adjustable latch. 2-3/8"-2-3/4"



### CODE COMPLIANCE:

- ANSIA117.1 and ADA for barrier-free accessibility
- NFPA101 National Fire Protection-Life Safety 2000

**1 YEAR LIMITED WARRANTY**

### Functions:

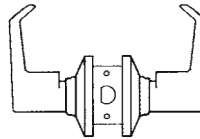

#### ECL10 Passage

- Latch by lever either side.
- Both levers always free.

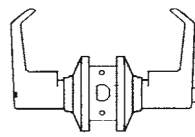

#### ECL40 Privacy

- Latch by lever either side.
- Outside lever locked by push button.
- Outside lever unlocked by emergency release or by rotating inside lever. Inside lever always free.

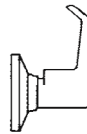

#### ECL170 Dummy

- Lever acts as pull only.
- No operation.

### Stocked Product

Item	Design	Finish
ECL10, ECL40, ECL170	LEV	10B, 26D, US3
PECL26DRD		26D

# Doormerica

## Lock - General Information

LEVER DIMENSIONS		A	B	C	D	E
LHV-SAT-SATURN	Grade 1	4-15/16	2-1/2	3-9/16	5/8	1/2
LHV-SPA-SPARTA	Grade 1	4-31/32	2-17/32	3-1/2	5/8	1/2
LHV-TUB-TUBULAR	Grade 1	4-15/16	2-13/32	3-9/16	5/8	1/2
LSV-SAT-SATURN	Grade 2	4-5/8	2-1/2	3-3/8	11/16	1/2
LSV-SPA-SPARTA	Grade 2	4-17/32	2-7/16	3-5/16	11/16	1/2
LDV-SAT-SATURN	Grade 2	4-5/16	2-1/2	2-15/16	1/2	1/2
LDV-SPA-SPARTA	Grade 2	4-17/32	2-7/16	3-5/16	11/16	1/2

SAT - Saturn

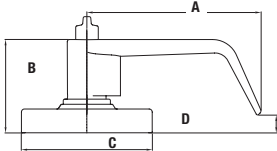

SPA - Sparta

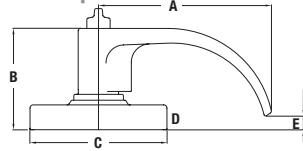

TUB - Tubular

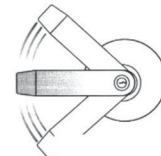
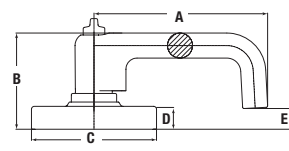

CL - Clutching Lever

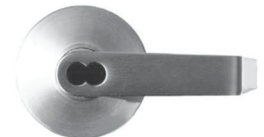

Small format Interchangeable available. Core NOT included.

	Function	ANSI	Function Description	LHV	LSV	LDV	ECL
	10	Passage F75	Latchbolt operated by handle from either side at all times	LHV10	LSV10	LDV10	ECL10
	20	Exit F111	Blank plate outside, inside lever always free	N/A	LSV20	LDV20	N/A
	40	Privacy F76	Push button locking from inside. Lock can be opened from outside with narrow flat-head screw driver or rotating inside lever	LHV40	LSV40	LDV40	ECL40
	50	Office	Entrance/Office Lock. Push-button locking. Push-button locks outside lever until unlocked with key or by rotating inside lever	LHV50	N/A	N/A	N/A
	53	Entrance F82	Pushing inside button locks outside trim requiring key to unlock. Pushing and twisting button locks outside lever and always requires a key to unlatch. Inside lever always allows free egress	LHV53	LSV53	LDV53	N/A
	70	Classroom F84	Outside lever locked our unlocked by key. Inside lever always allows free egress	LHV70	LSV70	LDV70	N/A
	75	Intruder Classroom* F110	Deadlocking latchbolt operated by handle from either side (inside handle always operates latchbolt). Key either inside or outside locks or unlocks outside handle. Key from either side retracts latchbolt.	LHV75	N/A	N/A	N/A
	80	Storeroom F86	Outside lever always locked. Key unlatches only. Inside lever always allows free egress	LHV80	LSV80	LDV80	N/A
	170	Dummy	Dummy trim for one side of door	LHV170	LSV170	LDV170	ECL170

\*The rose provides an intuitive marking etched into it to provide the user with a permanent visual indicator to identify which way to turn the key in order to lock the door from the interior or classroom side. The visual indicator may reduce the time required to ensure the lock is secure if the threat of an intruder were identified.