

Doormerica

LHV - Heavy Duty Commercial Cylindrical Locks-Grade 1



Saturn



Sparta



Tubular



Features:

- Non-Handed and Reversible.
- 2-3/4" Backset, 1-1/8"x 2-1/4" Face Plate, UL 3 Hour Fire Listed Stainless Steel Latch or Dead-latch.
- 1-1/4" x 4-7/8" ANSI Strike.
- Schlage "C" 6 Pin Keyway Standard.
- Saturn, Sparta and Tubular Lever Design.
- Barrier Free and Returns within 1/2" from the Door Face.
- Door Thickness 1-3/4" -2"

Options:

- CL -Clutch Function -Lever Rotates without Unlatching Lock.
- IC -Small format Interchangeable Core available for Saturn and Sparta lever design, Core NOT included.
- LFIC - Large Format Interchangeable Core available for Saturn lever design, Core NOT included.
- PLKLHVSL238 -2-3/8" Backset, Spring Latch. (SOLD SEPERATELY)
- PLKLHVDL238 -2-3/8" Backset. Dead Latch. (SOLD SEPERATELY)



CODE COMPLIANCE:

- ANSI A156.2 Grade 1. UL10C and UBC 7.2 for positive pressure.
- ANSIA117.1 and ADA for barrier-free accessibility
- C-UBC -California Amended Uniform Builders Code -2001
- NFPA-80 -National Fire Protection -1999
- NFPA-101 National Fire Protection-Life Safety 2000

LIMITED LIFETIME WARRANTY

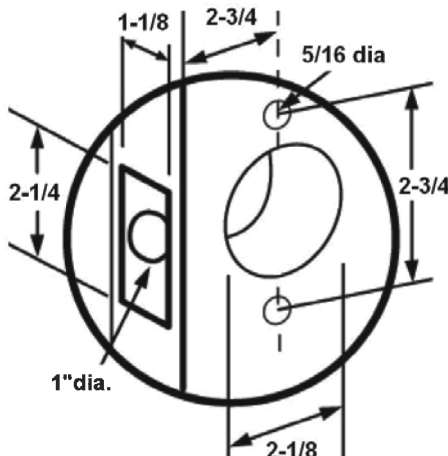

Stocked Product

Item	Style	Finish
LHV10, LHV40, LHV50, LHV53, LHV70, LHV75*, LHV80, LHV170	Saturn	10B, 26D
LHV10, LHV40, LHV50, LHV53, LHV70, LHV80, LHV170	Sparta	10B, 26D
LHV10, LHV40, LHV50, LHV53, LHV70, LHV80, LHV170	Tubular	26D
LHV53, LHV70, LHV80 IC core less core	Saturn	26D
LHV50, LHV53, LHV75, LHV80 LFIC core less core	Saturn	26D
LHV50, LHV53, LHV70, LHV80 IC core less core	Sparta	26D
LHVCL53, LHVCL70, LHVCL80 Clutch	Saturn	10B, 26D
LHVCL53, LHVCL70, LHVCL80 Clutch	Sparta	26D
LHVCL53, LHVCL70, LHVCL80 Clutch	Tubular	26D
LHVCL53, LHVCL70, LHVCL80 IC With clutch	Saturn	26D
LHVCL53, LHVCL70, LHVCL80 IC With clutch	Sparta	26D

*26D only

Doormerica

Lock - General Information

LEVER DIMENSIONS		A	B	C	D	E
LHV-SAT-SATURN	Grade 1	4-15/16	2-1/2	3-9/16	5/8	1/2
LHV-SPA-SPARTA	Grade 1	4-31/32	2-17/32	3-1/2	5/8	1/2
LHV-TUB-TUBULAR	Grade 1	4-15/16	2-13/32	3-9/16	5/8	1/2
LSV-SAT-SATURN	Grade 2	4-5/8	2-1/2	3-3/8	11/16	1/2
LSV-SPA-SPARTA	Grade 2	4-17/32	2-7/16	3-5/16	11/16	1/2
LDV-SAT-SATURN	Grade 2	4-5/16	2-1/2	2-15/16	1/2	1/2
LDV-SPA-SPARTA	Grade 2	4-17/32	2-7/16	3-5/16	11/16	1/2

SAT - Saturn

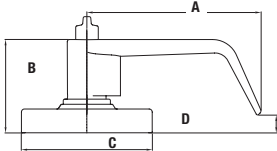

SPA - Sparta

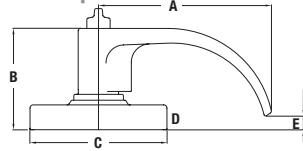



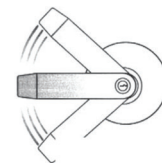
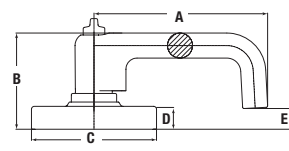



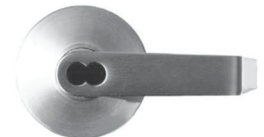

TUB - Tubular



CL - Clutching Lever



Small format Interchangeable available. Core NOT included.

	Function	ANSI	Function Description	LHV	LSV	LDV	ECL
	10	Passage F75	Latchbolt operated by handle from either side at all times	LHV10	LSV10	LDV10	ECL10
	20	Exit F111	Blank plate outside, inside lever always free	N/A	LSV20	LDV20	N/A
	40	Privacy F76	Push button locking from inside. Lock can be opened from outside with narrow flat-head screw driver or rotating inside lever	LHV40	LSV40	LDV40	ECL40
	50	Office	Entrance/Office Lock. Push-button locking. Push-button locks outside lever until unlocked with key or by rotating inside lever	LHV50	N/A	N/A	N/A
	53	Entrance F82	Pushing inside button locks outside trim requiring key to unlock. Pushing and twisting button locks outside lever and always requires a key to unlatch. Inside lever always allows free egress	LHV53	LSV53	LDV53	N/A
	70	Classroom F84	Outside lever locked or unlocked by key. Inside lever always allows free egress	LHV70	LSV70	LDV70	N/A
	75	Intruder Classroom* F110	Deadlocking latchbolt operated by handle from either side (inside handle always operates latchbolt). Key either inside or outside locks or unlocks outside handle. Key from either side retracts latchbolt.	LHV75	N/A	N/A	N/A
	80	Storeroom F86	Outside lever always locked. Key unlatches only. Inside lever always allows free egress	LHV80	LSV80	LDV80	N/A
	170	Dummy	Dummy trim for one side of door	LHV170	LSV170	LDV170	ECL170

*The rose provides an intuitive marking etched into it to provide the user with a permanent visual indicator to identify which way to turn the key in order to lock the door from the interior or classroom side. The visual indicator may reduce the time required to ensure the lock is secure if the threat of an intruder were identified.